

BX Series

Terminal type and Long sensing distance type

■ Features

- Built-in sensitivity adjustment VR
- Timer function: ON Delay, OFF Delay, One-shot Delay
- NPN/PNP open collector output(DC power type)
- Self-diagnosis function(Green LED turns ON in stable level)
- Wide power supply range: Universal 24-240VDC/24-240VAC
- Protection structure IP66(IEC standard)

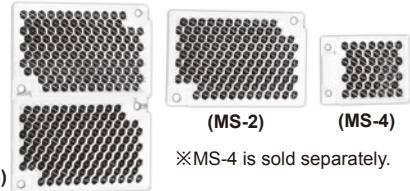

(MS-2) (MS-4)

※MS-4 is sold separately.

⚠ Please read "Caution for your safety" in operation manual before using.



(MS-3)

■ Specifications

◎ Free power type, Relay contact output type

Model	Standard type	BX15M-TFR	BX5M-MFR	BX3M-PFR	BX700-DFR
	With Timer	BX15M-TFR-T	BX5M-MFR-T	BX3M-PFR-T	BX700-DFR-T
Sensing type		Through-beam	Retroreflective (Standard type)	Retroreflective (Built-in polarizing filter)	Diffuse reflective
Sensing distance		15m	0.1 to 5m(MS-2) ^{※1}	0.1 to 3m(MS-3) ^{※2}	700mm ^{※3}
Sensing target		Opaque materials of Min. ø15mm	Opaque materials of Min. ø60mm		Translucent, opaque material
Hysteresis		—			Max. 20% at rated setting distance
Response time		Max. 20ms			
Power supply		24-240VAC ±10% 50/60Hz, 24-240VDC ±10%(Ripple P-P:Max. 10%)			
Power consumption		Max. 3VA			
Light source		Infrared LED(850nm)		Red LED(660nm)	Infrared LED(940nm)
Sensitivity adjustment		Built-in the adjustment VR			
Operation mode		Selectable Light ON or Dark ON by switch			
Control output		Relay contact output(Contact capacity : 30VDC 3A, 250VAC 3A at resistive load, Contact composition: 1c) ^{※4}			
Relay life cycle		Mechanically : Min. 50,000,000, Electrically : Min. 100,000			
Self-diagnosis output		Green LED turns on at stable operation			
Timer function		Selectable ON Delay, OFF Delay, One Shot Delay by slide switch [Delay Time : 0.1 to 5sec.(Adjustable VR)]			
Indicator		Operation indicator : yellow LED, Self-diagnosis indicator : green LED			
Insulation resistance		Min. 20MΩ(at 500VDC megger)			
Insulation type		Double or strong insulation(Mark:  , Dielectric voltage between the measured input and the power: 1.5kV)			
Noise resistance		±1,000V the square wave noise(pulse width : 1μs) by the noise simulator			
Dielectric strength		1500VAC 50/60Hz for 1minute			
Vibration	Mechanical	1.5mm amplitude or 300m/s ² at frequency of 10 to 55Hz(for 1 min.) in each of X, Y, Z directions for 2 hours			
	Malfunction	1.5mm amplitude or 300m/s ² at frequency of 10 to 55Hz(for 1 min.) in each of X, Y, Z directions for 10 minutes			
Shock	Mechanical	500m/s ² (approx. 50G) in each of X, Y, Z directions for 3 times			
	Malfunction	100m/s ² (approx. 10G) in each of X, Y, Z directions for 3 times			
Environment	Ambient illumination	Sunlight : Max. 11,000lx, Incandescent lamp : Max. 3,000lx (Receiver illumination)			
	Ambient temperature	-20 to 55°C, storage : -25 to 70°C			
	Ambient humidity	35 to 85%RH, storage : 35 to 85%RH			
Protection		IP66(IEC standard)			
Material		Case, Lens cover: PC, Sensing part: Acrylic			
Accessory	Individual	—	Mirror(MS-2)	Mirror(MS-3)	—
	Common	VR adjustment driver, Mounting bracket, Bolts, Nuts			
Approval		CE			
Unit weight		TFR: Approx. 225g TFR-T: Approx. 226g	MFR: Approx. 130g MFR-T: Approx. 131g	PFR: Approx. 148g PFR-T: Approx. 149g	DFR: Approx. 115g DFR-T: Approx. 116g

※1: It is same when using the MS-4 reflector (sold separately). The sensor can detect under 0.1m.

※2: When using the MS-2 reflector, the sensing distance is 0.1 to 2m. The sensor can detect under 0.1m.

※3: It is for Non-glossy white paper(200×200mm)

※4: Relay contact output 1a type is option.

※Relay contact output 1a type is option.

※The temperature or humidity mentioned in Environment indicates a non freezing or condensation environment.

Long Sensing, Amplifier Built-in type with Universal voltage (terminal)

■ Specifications

◎ DC power type, Solid state output type

Model	Standard type	BX15M-TDT	BX5M-MDT	BX3M-PDT	BX700-DDT
	With Timer	BX15M-TDT-T	BX5M-MDT-T	BX3M-PDT-T	BX700-DDT-T
Sensing type	Through-beam		Retroreflective (Standard type)	Retroreflective (Built-in polarizing filter)	Diffuse reflective
Sensing distance	15m		0.1 to 5m(MS-2) ^{※1}	0.1 to 3m(MS-3) ^{※2}	700mm ^{※3}
Sensing target	Opaque materials of Min. ø15mm		Opaque materials of Min. ø60mm		Translucent, opaque material
Hysteresis	—				Max. 20% at rated setting distance
Response time	Max. 1ms				
Power supply	12-24VDC ±10%(Ripple P-P:Max. 10%)				
Current consumption	Max. 50mA				
Light source	Infrared LED(850nm)			Red LED(660nm)	Infrared LED(940nm)
Sensitivity adjustment	Built-in VR				
Operation mode	Selectable Light ON or Dark ON by switch				
Control output	NPN or PNP open collector output ●Load voltage: Max. 30VDC ●Load current: Max. 200mA ●Residual voltage - NPN:Max. 1V, PNP:Max. 2.5V				
Relay life cycle	Mechanically : Min. 50,000,000, Electrically : Min. 100,000				
Self-diagnosis output	Green LED turns on at unstable operation and output(transistor output) turns on				
Timer function	Selectable ON Delay, OFF Delay, One Shot Delay by slide switch [Delay Time : 0.1 to 5sec.(Adjustable VR)]				
Indicator	Operation indicator : yellow LED, Self-diagnosis indicator : green LED				
Insulation resistance	Min. 20MΩ(at 500VDC megger)				
Noise resistance	±240V the square wave noise(pulse width : 1μs) by the noise simulator				
Dielectric strength	1500VAC 50/60Hz for 1minute				
Vibration	Mechanical	1.5mm amplitude or 300m/s ² at frequency of 10 to 55Hz(for 1 min.) in each of X, Y, Z directions for 2 hours			
	Malfunction	1.5mm amplitude or 300m/s ² at frequency of 10 to 55Hz(for 1 min.) in each of X, Y, Z directions for 10 minutes			
Shock	Mechanical	500m/s ² (approx. 50G) in each of X, Y, Z directions for 3 times			
	Malfunction	100m/s ² (approx. 10G) in each of X, Y, Z directions for 3 times			
Environment	Ambient illumination	Sunlight : Max. 11,000lx , Incandescent lamp : Max. 3,000lx (Receiver illumination)			
	Ambient temperature	-20 to 55°C, storage : -25 to 70°C			
	Ambient humidity	35 to 85%RH, storage : 35 to 85%RH			
Protection	IP66(IEC standard)				
Material	Case, Lens cover: PC, Sensing part: Acrylic				
Accessory	Individual	—	Mirror(MS-2)	Mirror(MS-3)	—
	Common	VR adjustment driver, Mounting bracket, Bolts, Nuts			
Approval	CE				
Unit weight	TDT: Approx. 211g TDT-T: Approx. 212g		MDT: Approx. 123g MDT-T: Approx. 124g	PDT: Approx. 141g PDT-T: Approx. 142g	DDT: Approx. 116g DDT-T: Approx. 117g

※1: It is same when using the MS-4 reflector (sold separately). The sensor can detect under 0.1m.

※2: When using the MS-2 reflector, the sensing distance is 0.1 to 2m. The sensor can detect under 0.1m.

※3: It is for Non-glossy white paper(200×200mm)

※The temperature or humidity mentioned in Environment indicates a non freezing or condensation environment.

(A)
Photo
electric
sensor

(B)
Fiber
optic
sensor

(C)
Door/Area
sensor

(D)
Proximity
sensor

(E)
Pressure
sensor

(F)
Rotary
encoder

(G)
Connector/
Socket

(H)
Temp.
controller

(I)
SSR/
Power
controller

(J)
Counter

(K)
Timer

(L)
Panel
meter

(M)
Tacho/
Speed/
Pulse
meter

(N)
Display
unit

(O)
Sensor
controller

(P)
Switching
mode power
supply

(Q)
Stepper
motor&
Driver&Controller

(R)
Graphic/
Logic
panel

(S)
Field
network
device

(T)
Software

(U)
Other

BX Series

Feature data

Through-beam type

- BX15M-TFR / BX15M-TFR-T
- BX15M-TDT / BX15M-TDT-T

Diffuse reflective type

- BX700-DFR / BX700-DFR-T
- BX700-DDT / BX700-DDT-T

Parallel shifting characteristic		Angle Characteristic		Sensing area	
Measuring method	Data	Measuring method	Data	Measuring method	Data
<p>Receiver</p> <p>Emitter</p>	<p>Sensing distance L (m)</p> <p>Left ← Center → Right</p> <p>Sensing area(cm)</p>	<p>Receiver</p> <p>Emitter</p>	<p>Sensing distance L (m)</p> <p>Left ← Center → Right</p> <p>Operation angle θ</p>	<p>Receiver</p> <p>Diffuse reflective</p>	<p>Sensing distance L (m)</p> <p>Left ← Center → Right</p> <p>Sensing area(mm)</p>

Retroreflective type

- BX5M-MFR / BX5M-MFR-T
- BX5M-MDT / BX5M-MDT-T

Parallel shifting characteristic		Angle Characteristic		Reflector angle characteristic	
Measuring method	Data	Measuring method	Data	Measuring method	Data
<p>Reflector (MS-2)</p> <p>Retroreflective type(standard type)</p>	<p>Sensing distance L (m)</p> <p>Left ← Center → Right</p> <p>Sensing area(mm)</p>	<p>Reflector (MS-2)</p> <p>Retroreflective type(standard type)</p>	<p>Sensing distance L (m)</p> <p>Left ← Center → Right</p> <p>Operation angle θ</p>	<p>Reflector (MS-2)</p> <p>Retroreflective type(standard type)</p>	<p>Sensing distance L (m)</p> <p>Left ← Center → Right</p> <p>Operation angle θ</p>

Retroreflective type(Built-in polarizing filter)

- BX3M-PFR / BX3M-PFR-T
- BX3M-PDT / BX3M-PDT-T

Parallel shifting characteristic		Sensor angle characteristic		Reflector angle characteristic	
Measuring method	Data	Measuring method	Data	Measuring method	Data
<p>Reflector (MS-2)</p> <p>Retroreflective type(Built-in polarizing filter)</p>	<p>Sensing distance L (m)</p> <p>Left ← Center → Right</p> <p>Sensing area(mm)</p>	<p>Reflector (MS-2)</p> <p>Retroreflective type(Built-in polarizing filter)</p>	<p>Sensing distance L (m)</p> <p>Left ← Center → Right</p> <p>Operation angle θ</p>	<p>Reflector (MS-2)</p> <p>Retroreflective type(Built-in polarizing filter)</p>	<p>Sensing distance L (m)</p> <p>Left ← Center → Right</p> <p>Operation angle θ</p>

Long Sensing, Amplifier Built-in type with Universal voltage (terminal)

■ Control output diagram

- ◎ Free power type (Relay contact output)

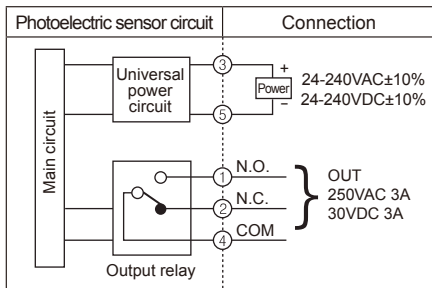

- ◎ DC power type (NPN/PNP open collector simultaneous output)

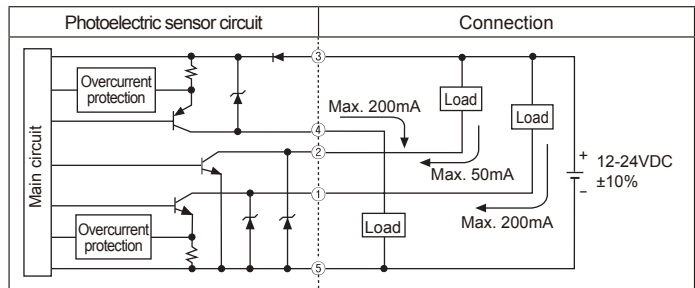

※ In case of product with the output protection device, if terminals of control output are short-circuited or overcurrent condition exists, the control output will turn off due to protection circuit.

■ Operation timing diagram

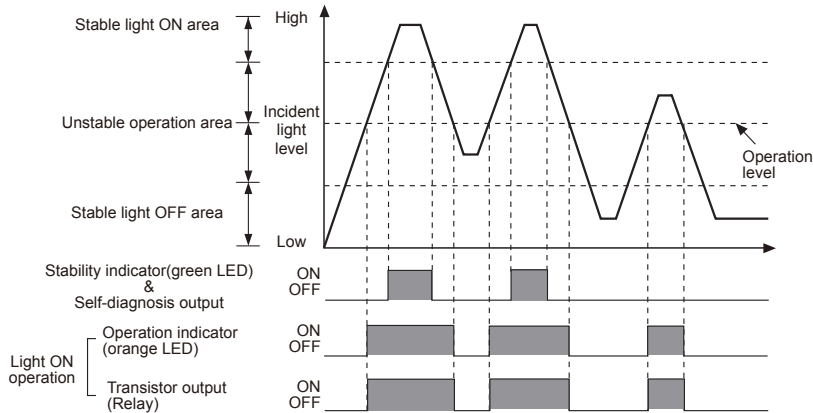

※ The waveforms of "Operation indicator" and "Transistor output" are for Light ON operation. They are opposite operation for Dark ON operation.
 ※ If the control output terminal is short-circuit or over current than the rated current flows in the unit, the sensor does not operate normally by protection circuit.

■ Timer mode

Timer mode	Switch position		Status of light	Received light	Interrupted light
	S1	S2			
Normal	ON	ON	Light ON	ON	[Pulse]
			Dark ON	OFF	[Pulse]
One-shot Delay	ON	OFF	Light ON	ON	[Pulse with delay T]
			Dark ON	OFF	[Pulse with delay T]
ON Delay	OFF	ON	Light ON	ON	[Pulse with delay T]
			Dark ON	OFF	[Pulse with delay T]
OFF Delay	OFF	OFF	Light ON	ON	[Pulse with delay T]
			Dark ON	OFF	[Pulse with delay T]

※ T : Time set by the timer adjustment VR.

※ Conversion to another mode of timer modes is applied after a former mode is finished.

(A) Photo electric sensor

(B) Fiber optic sensor

(C) Door/Area sensor

(D) Proximity sensor

(E) Pressure sensor

(F) Rotary encoder

(G) Connector/ Socket

(H) Temp. controller

(I) SSR/ Power controller

(J) Counter

(K) Timer

(L) Panel meter

(M) Tacho/ Speed/ Pulse meter

(N) Display unit

(O) Sensor controller

(P) Switching mode power supply

(Q) Stepper motor & Driver & Controller

(R) Graphic/ Logic panel

(S) Field network device

(T) Software

(U) Other

BX Series

■ Connections

◎ Through-beam type

● BX15M-TFR1

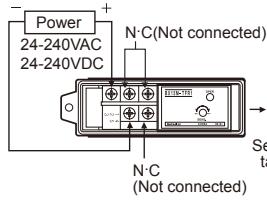

● BX15M-TFR2 BX15M-TFR2-T

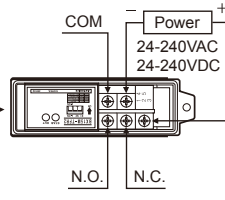

● BX15M-TDT1

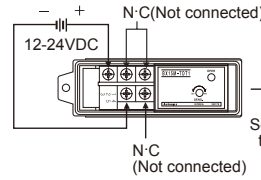

● BX15M-TDT2 BX15M-TDT2-T

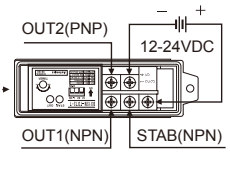

◎ Retroreflective type / Retroreflective type with polarizing filter

● BX5M-MFR, BX5M-MFR-T(Standard type)

● BX3M-PFR, BX3M-PFR-T(Built-in polarizing filter)

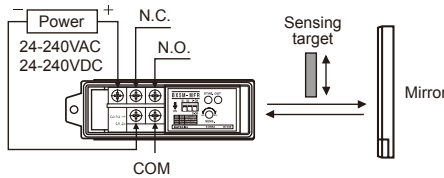

● BX5M-MDT, BX5M-MDT-T(Standard type)

● BX3M-PDT, BX3M-PDT-T(Built-in polarizing filter)

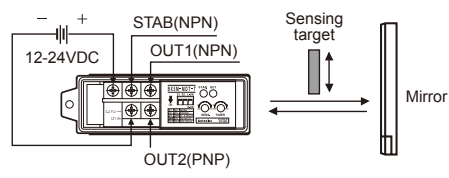

◎ Diffuse reflective type

● BX700-DFR, BX700-DFR-T

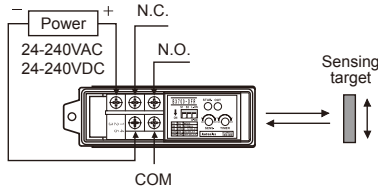

● BX700-DDT, BX700-DDT-T

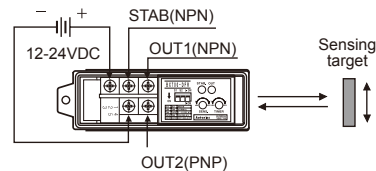

◎ Cable

(unit: mm)

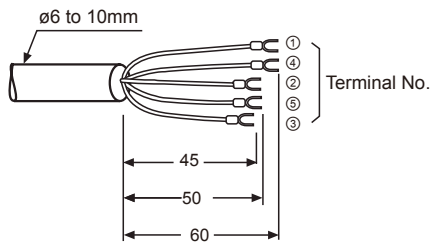

● Crimp terminal size

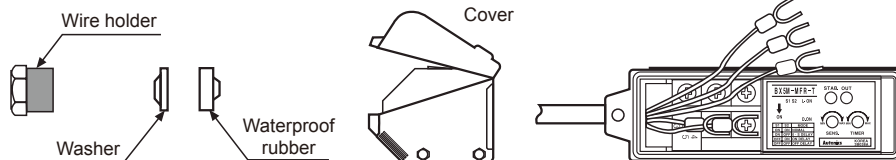
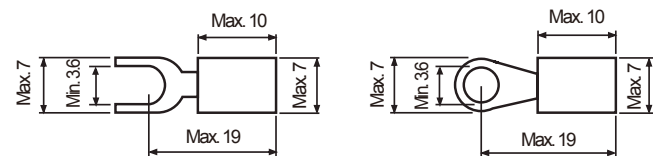

※ To connect the wires on the terminal, follow as above figures.

※ Select the round wire with the size of ø6 to 10mm for the waterproof and tighten the cable holder by torque of 1.0 to 1.5N·m.

※ To connect the wires on the terminal, tighten screws by torque of 0.8N·m.

Long Sensing, Amplifier Built-in type with Universal voltage (terminal)

■ Front panel identification

◎ Through-beam type

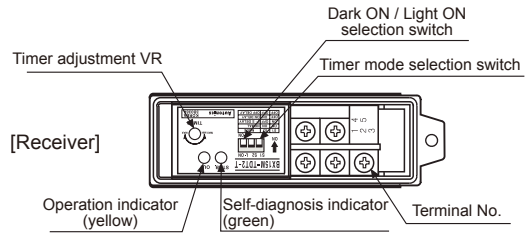
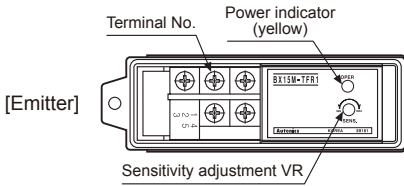

◎ Retroreflective type (Standard type, Built-in polarizing filter)

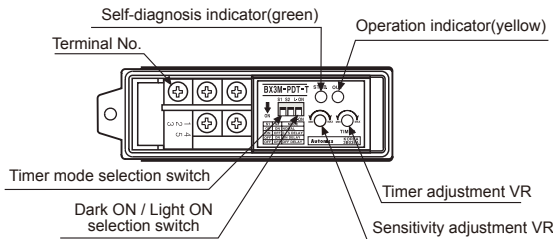

◎ Diffuse reflective type

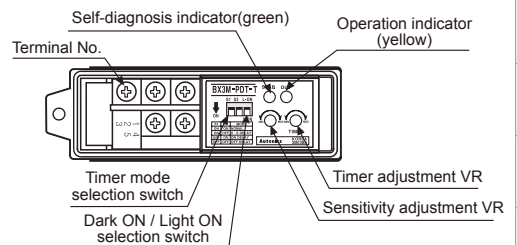

※ There are no Timer mode selection switch and the timer adjustment VR in type without Timer function.

■ Dimensions

(unit: mm)

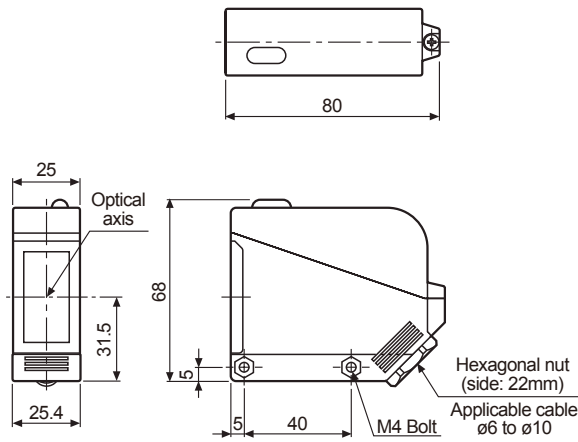

● Connect the bracket

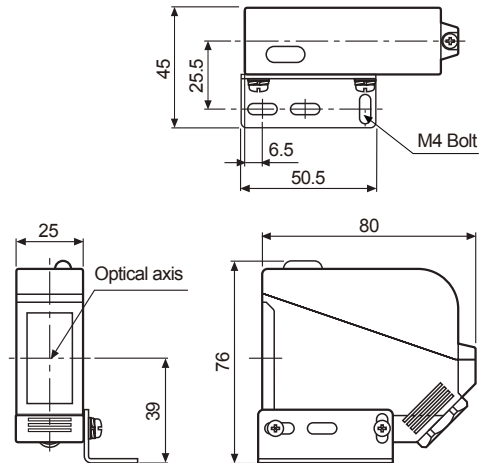

● Bracket

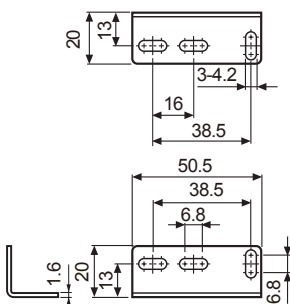

● Mirror

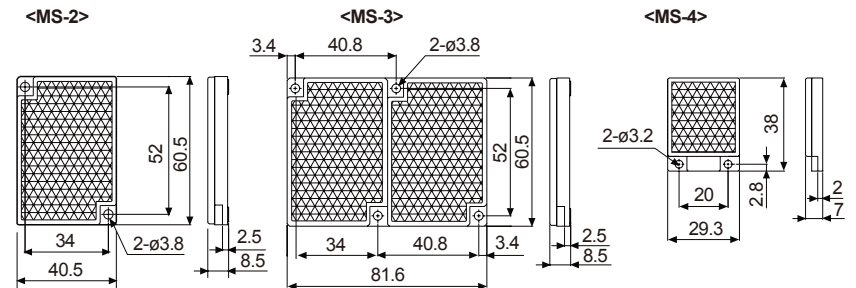

(A) Photo electric sensor

(B) Fiber optic sensor

(C) Door/Area sensor

(D) Proximity sensor

(E) Pressure sensor

(F) Rotary encoder

(G) Connector/Socket

(H) Temp. controller

(I) SSR/ Power controller

(J) Counter

(K) Timer

(L) Panel meter

(M) Tacho/ Speed/ Pulse meter

(N) Display unit

(O) Sensor controller

(P) Switching mode power supply

(Q) Stepper motor & Driver & Controller

(R) Graphic/ Logic panel

(S) Field network device

(T) Software

(U) Other

■ Mounting and sensitivity adjustment

◎ Through-beam type

1. Supply the power to the photoelectric sensor, after setting the emitter and the receiver facing each other.
 2. Set the receiver in center of position in the middle of the operation range of indicator adjusting the receiver or the emitter right and left, up and down.
 3. After adjustment, check the stability of operation putting the object at the optical axis.
- ※If the sensing target is translucent body or smaller than $\varnothing 15\text{mm}$, it can be missed by sensor cause light penetrate it.
- ※Sensitivity adjustment: Refer to the diffuse reflective type's.

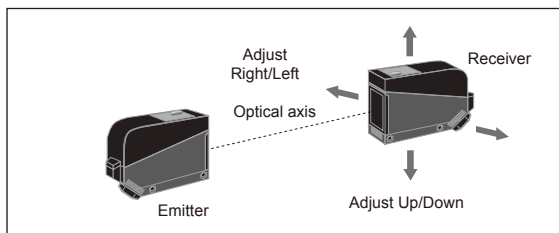

◎ Diffuse reflective type

1. The sensitivity should be adjusted depending on a sensing target or mounting place.
 2. Set the target at a position to be detected by the beam, then turn the adjustment VR until position ㉑ where the operation indicator(yellow LED) turns ON and the self-diagnosis indicator(green LED) turns OFF from min. position of the adjustment VR.
 3. Take the target out of the sensing area, then turn the adjustment VR until position ㉒ where the the operation indicator (yellow LED) turns OFF and the self-diagnosis indicator(green LED) turns ON. If the indicators do not operate, max. position is ㉒.
 4. Set the adjustment VR at the center of two switching position ㉑, ㉒.
- ※Above sensitivity adjustment is for Light ON mode. If it is for Dark ON mode, operation indicator(yellow LED) operates opposite.
- ※The sensing distance indicated on specification chart is for 200×200mm of non-glossy white paper. Be sure that it can be different by size, surface and gloss of target.

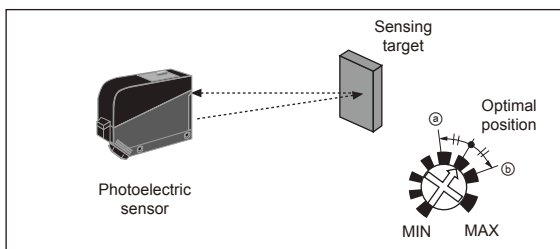

◎ Retroreflective type

1. Supply the power to the photoelectric sensor, after setting the photoelectric sensor and the reflector(MS-2) in face to face.
 2. Set the photoelectric sensor in the position which indicator turns on, as adjusting the reflector or the sensor right and left, up and down.
 3. Fix both units tightly after checking that the unit detects the target.
- ※If using more than 2 photoelectric sensors in parallel, the space between them should be more than 30cm.
- ※If reflectance of target is higher than non-glossy white paper, it might cause malfunction by reflection from the target when the target is near to photoelectric sensor. Therefore put enough space between the target and the photoelectric sensor or the surface of the target should be installed at angle of 30° to 45° against optical axis. (When a sensing target with high reflectance near by, photoelectric sensing with the polarizing filter should be used.)
- ※Sensitivity adjustment: Refer to the diffuse reflective type's.

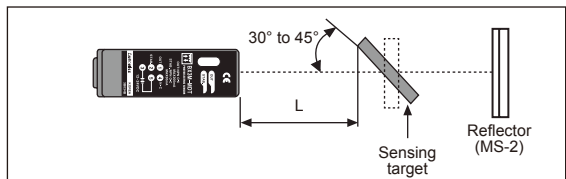
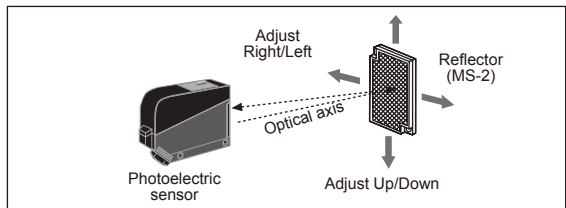

- ※If the mounting place is too narrow, please use MS-4 instead of MS-2.

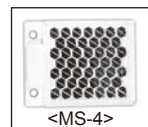

◎ Retroreflective type(Built-in polarizing filter)

The light passed through the polarizing filter of the emitter reaches to the MS-3 reflector converting as horizontal direction. It reaches to the receiver element of polarizing filter converting as vertical by the MS-3 reflector. Therefore, this type can also detect reflective mirror.

